

**BTE13 SP**

Sensei



Instructions for use

**oticon**  
PEOPLE FIRST

## Introduction to this booklet

This booklet guides you in how to use and maintain your new hearing aid. Please read the booklet carefully including the **Warning section**. This will help you to achieve the full benefit of your new hearing aid.

Your hearing care professional has adjusted the hearing aid to meet your needs. If you have additional questions, please contact your hearing care professional.

| **About** | [Start up](#) | [Handling](#) | [Options](#) | [Warnings](#) | [More info](#) |

For your convenience, this booklet contains a navigation bar to help you navigate easily through the different sections.

## Intended use

The hearing aid are intended to amplify and transmit sound to the ear and thereby compensate for impaired hearing. The hearing aid are intended to be used by infants, children and adults with a severe-to-profound hearing loss.

### IMPORTANT NOTICE

The hearing aid amplification is uniquely adjusted and optimised to your personal hearing capabilities during the hearing aid fitting performed by your hearing care professional.

## Table of content

### About

Hearing aid view	6
Identify left and right hearing aid	8
Battery (size 13)	9

### Start up

Turn the hearing aid on and off	10
When to replace a battery	11
Replace the battery	12

### Handling

Caring for your hearing aid	14
Sound hook with mould	16
Put on the hearing aid with mould	17
Put on the hearing aid with mould and SmartFit™ Trainer	18
Clean the mould	20
Wash the mould	21

### Options

Optional features and accessories	22
-----------------------------------	----

Mute the hearing aid (optional)	23
Change programs (optional)	24
Change volume	26
Volume Control and ConnectLine (Optional)	28
Tamper-resistant battery drawer (optional)	31
Wireless accessories (optional)	33
Direct Audio Input - DAI (optional)	34
FM (optional)	36
Other options (optional)	38
Audible and visual indicator (LED) summary table	40

### Warnings

Warnings	42
----------	----

### More info

Troubleshooting guide	48
Water resistant (IP58)	50
Conditions	51
Warranty certificate	52
International warranty	53
Technical information	54

## Hearing aid view

### What it is

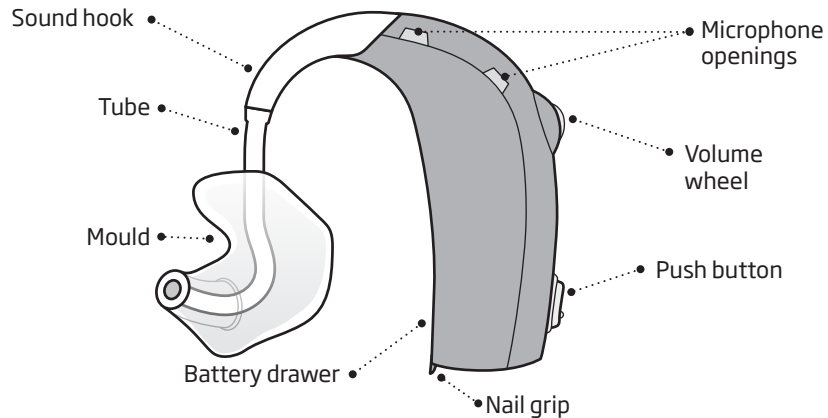

### What it does

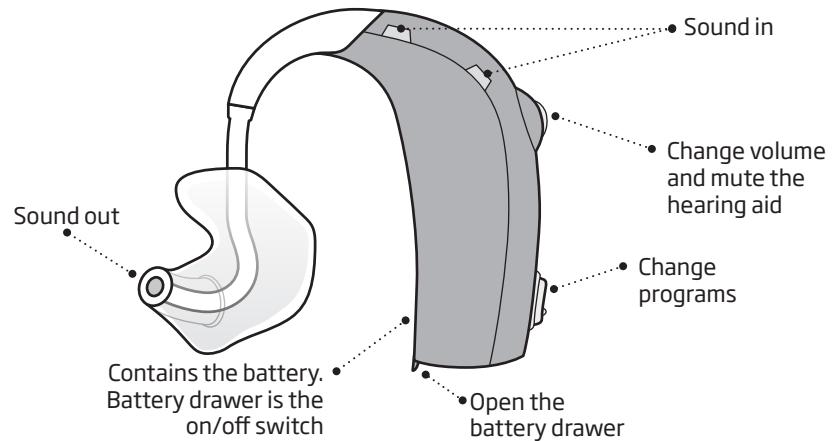

## Identify left and right hearing aid

It is important to distinguish between the left and the right hearing aid as they might be programmed differently.

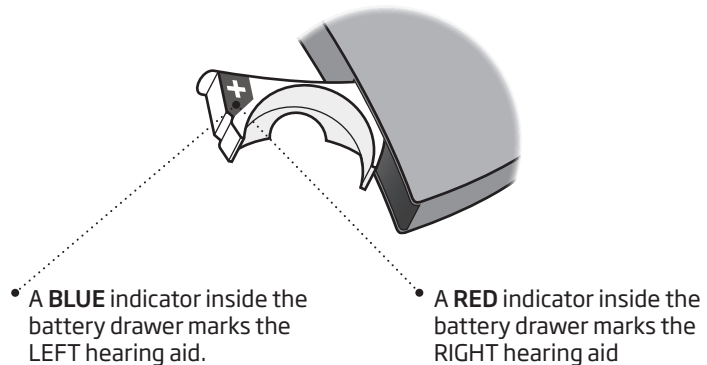

## Battery (size 13)

Your hearing aid is a miniature electronic device that runs on special batteries. To activate the hearing aid, you must insert a new battery in the battery drawer. See how in the “Replace the battery” section.

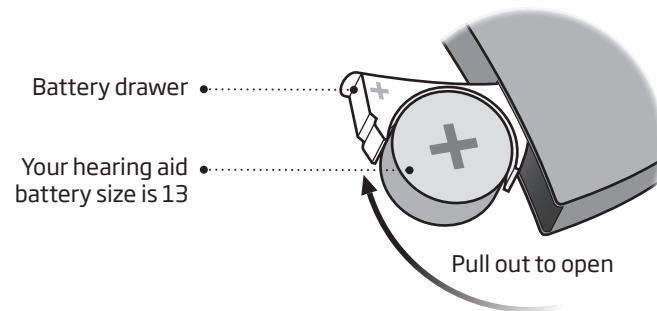



## Replace the battery

### 1. Remove

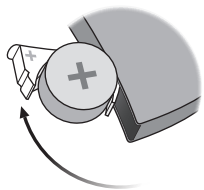

Fully open the battery drawer. Remove the battery.

### 2. Uncover



Remove the sticky label from the + side of the new battery.

### 3. Insert

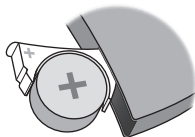

Insert the new battery into the battery drawer. Make sure the + side faces up.

### 4. Close

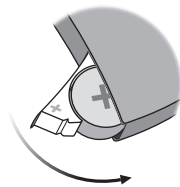

Close the battery drawer. The hearing aid will play a jingle through the earpiece. Hold the earpiece close to your ear to hear the jingle.

### Tip

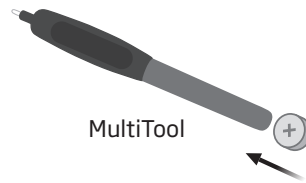

The MultiTool can be used for battery change. Use the magnetic end to remove and insert batteries.

The MultiTool is provided by your hearing care professional.

## Caring for your hearing aid

When handling your hearing aid, hold it over a soft surface to avoid damage in case you drop it.

### Clean the microphone openings

Carefully brush away debris from the openings. Gently brush the surface. Make sure the brush is not pressed in to the openings.

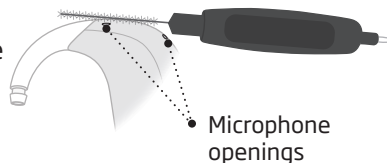

#### IMPORTANT NOTICE

Use a soft, dry cloth to clean the hearing aid. It must never be washed or immersed in water or other liquids.

## The MultiTool

The MultiTool contains a brush and a wire loop for cleaning ear wax from the mould. The brush can be replaced and purchased from your hearing care professional.

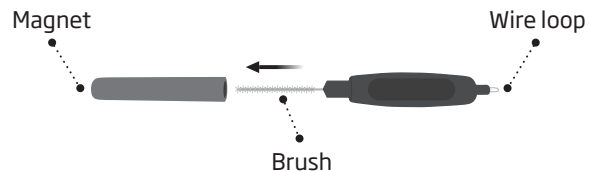

#### IMPORTANT NOTICE

Your MultiTool has a built-in magnet. Keep the MultiTool 30 cm away from credit cards and other magnetically sensitive devices.



## Sound hook with mould

The mould is customised for you and fits your ear.

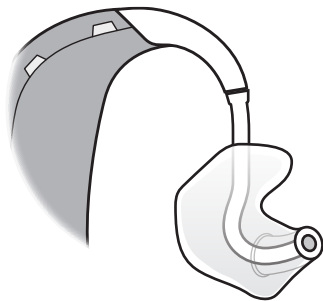

## Put on the hearing aid with mould

Step 1



Gently pull your ear outwards and press the mould in the direction of the ear canal, twisting slightly.

Step 2



Place the hearing aid behind your ear.

## **Put on the hearing aid with mould and SmartFit™ Trainer**

Your hearing aid may have SmartFit™ Trainer, a guidance tool for inserting the ear mould.

The LED indicator will remain on for up to 20 seconds while the system checks the ear mould insertion and fit. If the ear mould is NOT inserted correctly, a series of rapid blinks on the LED will appear.

If the blinks appear, turn the hearing aid off and on again, and reinsert the ear mould.

It may not be possible to insert the ear mould without the rapid blinks appearing. This is an indication that the ear mould may need replacing.

Your hearing care professional may enable or disable the SmartFit™ Trainer tool.

## Clean the mould

The mould should be cleaned regularly. Use a soft cloth to clean the surface of the mould. Use the MultiTool wire loop to clean the opening.

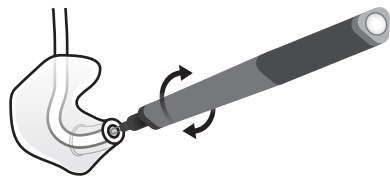

## Replace the tube

The tubing between the mould and the hearing aid should be replaced when it becomes yellow or stiff. Consult your hearing care professional in relation to this.

## Wash the mould

### Step 1



Make sure you are able to identify which mould is for which hearing aid before disconnecting them from the hearing aids.

### Step 2



Disconnect the tube and mould from the hook. Hold the hook firmly, when pulling off the tube. Otherwise the hearing aid may be damaged.

### Step 3

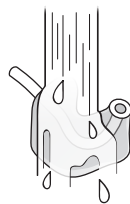

Wash the mould and tube using mild soap. Rinse and dry completely before reconnecting to the hearing aid.

## Optional features and accessories

The features and accessories described on the following pages are optional. Please contact your hearing care professional to find out how your hearing aid is programmed.

If you experience difficult listening situations, a special program may be helpful. These are programmed by your hearing care professional.

*Write down hearing situations where you may need help.*

---

---

---

### Mute the hearing aid (optional)

Use the mute function if you need to silence the hearing aid while wearing it.



Apply a very long press to the button to mute the hearing aid. To reactivate the hearing aid, push the button briefly.

#### **IMPORTANT NOTICE**

Do not use the mute function as an off switch, as the hearing aid still draws current from the battery in this mode.

## **Change programs** (optional)



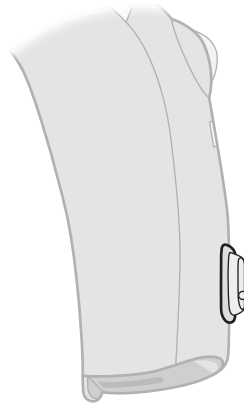

Your hearing aid can have up to 4 different programs. These are programmed by your hearing care professional. When using FM, DAI or Streamer, two additional programs are automatically added.



• Press the button to change program.

Note that if you have two hearing aids, the RIGHT hearing aid switches forward from e.g. program 1 to 2 and the LEFT hearing aid switches backwards from e.g. program 4 to 3.

## To be filled out by the hearing care professional

Program	Sound you will hear when activated	When to use
1	 "1 beep"	
2	 "2 beeps"	
3	 "3 beeps"	
4	 "4 beeps"	

Program change:

LEFT

RIGHT

Short press

Long press

Note, The LED indicates current program if enabled.

## Change volume

The volume wheel may be activated. The volume wheel allows you to adjust the volume in specific situations to the level you feel comfortable with.

The volume wheel has markings 1, 2, 3 and 4 and a 'click' position:

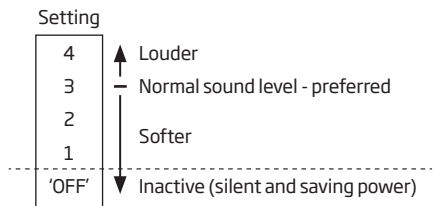

The normal volume wheel setting is 3. When adjusting the volume to the normal level you will hear a double beep.



Use the volume wheel to mute the hearing aid by turning below setting 1 until it clicks. To reactivate the hearing aid, turn up on the volume wheel.

### IMPORTANT NOTICE

Do not use the inactive 'click' position as an off switch as the hearing aid still draws power from the battery in this mode.

## **Volume Control and ConnectLine** (Optional)

Make sure to set the volume control on the hearing aid in the 1 to 4 range to enable use of the Streamer for remote control, phone calls and TV/music streaming. Streaming cannot be initiated while the hearing aid volume wheel is set to the inactive 'click' position.

If you use the Streamer to adjust the regular hearing aid listening volume, the resulting volume will no longer match the indications on the volume wheel. Turning the volume wheel to the inactive 'click' position and back into the 1-4 range or turning the hearing aid off and back on will reset the volume to the setting indicated on the volume wheel.

When adjusting the volume to the preferred level the visual indicator (LED) will blink and two beeps can be heard (if enabled).

During audio streaming, adjust the volume on the Streamer. The Streamer will control the volume independently of the setting of the volume wheel.

## Quick reset

If you wish to return to the standard settings of the hearing aid programmed by your hearing care professional, simply open and then close the battery drawer.

Open

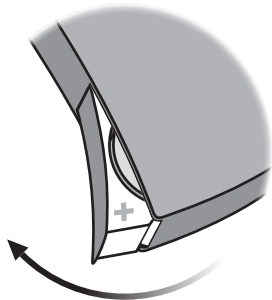

Close

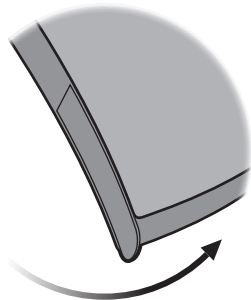

Note that volume setting is not changed with the quick reset.

## Tamper-resistant battery drawer (optional)

To keep the battery out of reach of infants, small children and people with learning difficulties, a tamper-resistant battery drawer should be used. Use a small screwdriver to lock and unlock the drawer.

### IMPORTANT NOTICE

Avoid excessive force to open the battery drawer when in the locked position. Do not force the battery drawer beyond its fully opened position. Make sure to insert the battery correctly.

Please contact your hearing care professional if you suspect the tamper-resistant effectiveness and locking ability is damaged.



### Unlock the battery drawer

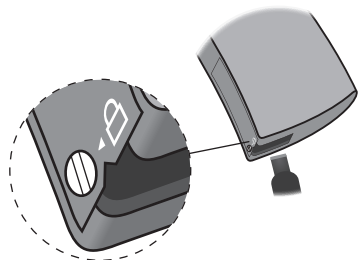

Use the screwdriver to turn the screw to unlock position (vertical). Insert the screwdriver into the slit in the bottom of the hearing aid and push the drawer open.

### Lock the battery drawer

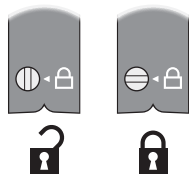

Make sure the drawer is completely closed. Turn the screw to the locked position (horizontal).

## **Wireless accessories** (optional)

As an enhancement to your wireless hearing aid a broad range of wireless accessories are available.

### **ConnectLine**

ConnectLine is a family of products that allows you to receive audio signals from TVs, phones, music players, PCs or an external microphone wirelessly through your hearing aid.

### **Remote Control**

The Remote Control offers an opportunity to change program or adjust the volume or mute your hearing aid.

## □ **Direct Audio Input - DAI** (optional)

DAI allows your hearing aid to receive signals directly from external sources such as TV, radio, music players, etc. The DAI adaptor is mounted to your hearing aid and via a cable connected to an external sound source.

For detailed information on these options contact your hearing care professional or visit [www.oticon.global](http://www.oticon.global)

### **IMPORTANT NOTICE**

Only connect hearing aids with DAI to electrically powered devices that comply with EN 60950-1, EN 60065 or equivalent safety standards. The external signal source determines the safety of hearing aids with DAI.

### **Attaching the DAI adapter**

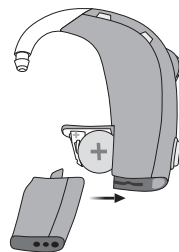

Start by opening the battery door and slide the DAI adapter onto the hearing aid.

### **Insert the DAI cord into the adapter**

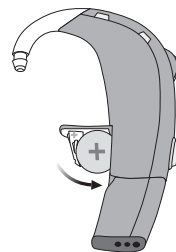

When the DAI adapter is connected, the hearing aid will automatically switch to a combination of a DAI program and the microphone input of the hearing aid. If you would like to turn off the hearing aid microphone input and listen to the DAI alone, you can advance to the next program by using the program switch button.

## □ **FM** (optional)

Your hearing aid supports the option of attaching an FM system. The FM system allows you to receive speech or audio signals directly to your hearing aid from a dedicated transmitter.

### Attaching an FM receiver

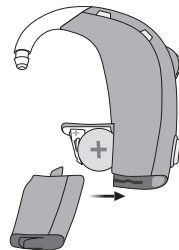

Start by opening the battery door. Slide the FM receiver onto the hearing aid.

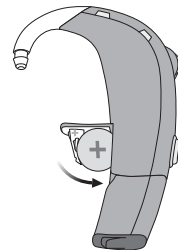

When the FM receiver is connected and turned on, the hearing aid will automatically switch to a program that receives signals from the microphone in combination with an external wireless FM transmitter.

## **Other options** (optional)



### **Telecoil**

Telecoil helps you hear better when using a telephone with a built-in loop or when you are in buildings with teleloop systems such as theatres, churches or lecture rooms. This symbol or a similar sign is shown wherever a teleloop has been installed.



### **Autophone**

Autophone can automatically activate a phone program in the hearing aid, if your telephone has a dedicated magnet. The magnet needs to be placed on your telephone next to the sound outlet.

## Audible and visual indicator (LED) summary table

Programs	Audible	Visual (LED)
Program 1		
Program 2		
Program 3		
Program 4		
FM or DAI + microphone		
FM or DAI		

Volume	Audible	Visual (LED)
Preferred volume		
Maximum volume		
Minimum volume		

Warnings	Audible	Visual (LED)
Battery low warning		
Battery dead		

SmartFit™ Trainer	Audible	Visual (LED)
Inserted correctly		
Reinsert ear mould		

## Warnings

You should familiarise yourself fully with the following general warnings before using your hearing aid for personal safety and to secure correct use.

Please note that a hearing aid will not restore normal hearing and will not prevent or improve a hearing impairment resulting from organic conditions. Furthermore, note that in most cases, infrequent use of a hearing aid does not permit a user to attain full benefit from it.

Consult your hearing care professional if you experience unexpected operations or events with your hearing aid.

### Usage of hearing aids

- Hearing aids should be used only as directed and adjusted by your hearing care professional. Misuse can result in sudden and permanent hearing loss.
- Never allow others to wear your hearing aid as incorrect use could cause permanent damage to their hearing.

### Choking hazards & risk of swallowing batteries

- Hearing aids, their parts, and batteries should be kept out of reach of children and anyone who might swallow these items, or otherwise cause injury to themselves.

- Batteries have occasionally been mistaken for pills. Therefore, check your medicine carefully before swallowing any pills.
- Most hearing aids can be supplied with a tamper-resistant battery drawer upon request. This is strongly recommended for infants, small children and people with learning difficulties.
- Children younger than 36 months must always use a tamper-resistant battery drawer. Please talk to your hearing care professional about the availability of this option.

*If a battery or hearing aid is swallowed, see a doctor immediately.*

### Battery use

- Always use batteries recommended by your hearing care professional. Batteries of low quality may leak and cause bodily harm.
- Never attempt to recharge your batteries and never dispose of batteries by burning them. There is a risk that the batteries will explode.

## Warnings

### Dysfunction

- Be aware of the possibility that your hearing aid may stop working without notice. Keep this in mind when you depend on warning sounds (e.g. when you are in traffic). The hearing aids may stop functioning, for instance if the batteries have expired or if the tubing is blocked by moisture or ear wax.

### Active implants

- Caution must be taken with active implants. In general, follow the guidelines recommended by manufacturers of implantable defibrillators and pacemakers regarding use with mobile phones and magnets.

- The Autophone magnet and Multi-Tool (which has a built-in magnet) should be kept a least 30 cm away from the implant, e.g. do not carry it in a breast pocket.
- If you have an active brain implant, please contact the manufacturer of your implantable device for information about the risk of disturbance.

### X-ray, CT, MR, PET scanning and electrotherapy

- Remove your hearing aid for example during X-ray, CT/MR/PET scanning electrotherapy or surgery as your hearing aid may be damaged when exposed to strong fields.

### Heat and chemicals

- Your hearing aid must never be exposed to extreme heat e.g. left inside a parked car in the sun.
- Your hearing aid must not be dried in microwave ovens or other ovens.
- The chemicals in cosmetics, hair-spray, perfume, aftershave lotion, suntan lotion and insect repellent can damage your hearing aid. Always remove your hearing aid before applying such products and allow time to dry before putting it on.

### Power instrument

- This is a power instrument and special care should be exercised in selecting, fitting and using a hearing aid where maximum sound pressure capability exceeds 132 dB SPL (IEC 711), as there may be risk of impairing the remaining hearing of the hearing aid user.

## Warnings

### Possible side effects

- Hearing aids, moulds or domes may cause an accelerated accumulation of ear wax.
- The otherwise non-allergenic materials used in hearing aids may in rare cases cause a skin irritation or any other unusual condition.

*Please seek consultation with a physician if these conditions occur.*

### Interference

- Your hearing aid has been thoroughly tested for interference, according to the most stringent international standards. However, interference with your hearing aid and other devices may occur, (e.g. some mobile telephones, citizens band systems and shop alarm systems). If this occurs, increase the distance between the hearing aid and the device.

### Connection to external equipment

- The safety of the hearing aid when connected to external equipment (via auxiliary input cable, via USB cable, or directly), is determined by the external equipment. When connected to external equipment plugged into a wall outlet, this equipment must comply with IEC-60065, IEC-60950 or equivalent safety standards.



## Troubleshooting guide

Symptom	Possible causes	Solutions
<b>No sound</b>	Worn-out battery	Replace the battery
	Clogged tube or earpieces	Clean mould
<b>Intermittent or reduced sound</b>	Clogged sound outlet	Clean mould
	Moisture	Wipe battery with a dry cloth and/or dry tube
	Worn-out battery	Replace the battery
	Clogged damping filter in sound hook	Contact your hearing care professional for assistance
<b>Squealing noise</b>	Hearing aid earpiece inserted incorrectly	Re-insert earpiece (mould)
	Ear wax accumulated in ear canal	Have ear canal examined by your doctor

If none of the above solutions works, consult your hearing care professional for assistance.

## Water resistant (IP58)

Your hearing aid is water resistant, which means it is designed to be worn in all daily life situations. Therefore, you do not have to worry about sweat or getting wet in a rain shower. Should your hearing aid come in contact with water and stop working, please follow these guidelines:

1. Gently wipe off any water
2. Open the battery drawer and remove the battery and gently wipe off any water in the battery drawer
3. Let the hearing aid dry with the battery drawer left open for approximately 30 minutes
4. Insert a new battery

### IMPORTANT NOTICE

Do not wear your hearing aid while showering or participating in water activities. Do not immerse your hearing aid in water or other liquids.

## Conditions

<b>Operating conditions</b>	Temperature: +1°C to +40°C Relative humidity: 5% to 93%, non-condensing
<b>Storage and transportation conditions</b>	Temperature and humidity shall not exceed the below limits for extended periods during transportation and storage:  Temperature: -25°C to +60°C Relative humidity: 5% to 93%, non-condensing

## Warranty certificate

Name of owner: \_\_\_\_\_

Dispenser: \_\_\_\_\_

Dispenser address: \_\_\_\_\_

Dispenser phone: \_\_\_\_\_

Purchase date: \_\_\_\_\_

Warranty period: \_\_\_\_\_ Month: \_\_\_\_\_

Model left: \_\_\_\_\_ Serial no.: \_\_\_\_\_

Model right: \_\_\_\_\_ Serial no.: \_\_\_\_\_

Battery size: \_\_\_\_\_

## International warranty

Your hearing aid is covered by an international limited warranty issued by the manufacturer for a period of 12 months from the date of delivery. This limited warranty covers manufacturing and material defects in the hearing aid itself, but not accessories such as batteries, tubing, ear wax filters, etc. Problems arising from improper handling or care, excessive use, accidents, repairs made by an unauthorised party, exposure to corrosive conditions, physical changes in your ear, damage due to foreign objects entering the device, or incorrect adjustments are NOT covered by the limited warranty and may void it. The above warranty does not affect any legal rights that you might have under applicable national legislation

governing the sale of consumer goods. Your hearing care professional may have issued a warranty that goes beyond the clauses of this limited warranty. Please consult him/her for further information.

### **If you need service**

Take your hearing aid to your hearing care professional, who may be able to sort out minor problems and adjustments immediately.

## Technical information

The hearing aid contains a radio transmitter using short range magnetic induction technology working at 3.84 MHz. The magnetic field strength of the transmitter is < -42 dB $\mu$ A/m at a 10 meter distance.

The hearing aid complies with international standards concerning radio transmitters, electro-magnetic compatibility and human exposure. Due to the limited space available on the instruments all relevant approval markings are found in this document.

Due to the limited space available on the hearing aids, all relevant approval markings are found in this document. Additional information can be found in the Product Information sheet on [oticon.global](http://oticon.global).

### USA and Canada

The hearing aid contains a radio module with the following certification ID numbers:

FCC ID: U28FU2SP  
IC: 1350B-FU2SP

The device complies with Part 15 of the FCC Rules and with Industry Canada's licence-exempt RSSs.

Operation is subject to the following two conditions:

1. This device may not cause harmful interference.
2. This device must accept any interference received, including interference that may cause undesired operation.

Changes or modifications not expressly approved by the party responsible for compliance could void the user's authority to operate the equipment.

This Class B digital apparatus complies with Canadian ICES-003.

Note: This equipment has been tested and found to comply with the limits for a Class B digital device, pursuant to part 15 of the FCC Rules. These limits are designed to provide reasonable protection against harmful interference in a residential installation. This equipment generates, uses and can radiate radio frequency energy and, if not installed and used in accordance with the instructions, may cause harmful interference to radio communications. However, there is no guarantee that interference will not occur in a particular installation. If this equipment does cause harmful interference to radio or television reception, which can be determined

by turning the equipment off and on, the user is encouraged to try to correct the interference by one or more of the following measures:

- Reorient or relocate the receiving antenna.
- Increase the separation between the equipment and receiver.
- Connect the equipment into an outlet on a circuit different from that to which the receiver is connected.
- Consult the manufacturer or an experienced radio/TV technician for help.

The manufacturer declares that this hearing aid is in compliance with the essential requirements and other relevant provisions of Directive 2014/53/EU (RED).

CE 0543



Waste from electronic equipment must be handled according to local regulations.

Declaration of Conformity is available from the manufacturer.









Manufactured by:  
Oticon A/S  
Kongebakken 9  
DK-2765 Smørum  
Denmark  
[www.oticon.global](http://www.oticon.global)







IP58

### Description of symbols used in this booklet

	<b>Warnings</b> Text marked with a marking symbol must be read before using the product.
	<b>Manufacturer</b> The product is produced by the manufacturer whose name and address are stated next to the symbol. Indicates the medical device manufacturer, as defined in EU Directives 90/385/EEC, 93/42/EEC and 98/79/EC.
	<b>CE mark</b> The product complies with Medical Device Directive 93/42/EEC. The four digits number indicates the identification of the notified body.
	<b>Electronic waste (WEEE)</b> Recycle your hearing aids, accessories or batteries according to local regulations or return them to your hearing care professional for disposal. Electronic equipment covered by Directive 2012/19/EU on waste and electrical equipment (WEEE).
	<b>Regulatory Compliance Mark (RCM)</b> The product complies with electrical safety, EMC and radio spectrum requirements for products supplied to the Australian or New Zealand market.
	<b>IP code</b> This symbol indicates the class of protections against harmful ingress of water and particulate matter according to EN 60529:1991/A1:2002. IP5X indicates dust protection. IPX8 indicates the protection against the effects of continuous immersion in water.

### Description of symbols used on the packaging label

	<b>Keep dry</b> Indicates a medical device that needs to be protected from moisture.
	<b>Caution symbol</b> Consult instructions for use for warnings and cautions.
	<b>Catalogue number</b> Indicates the manufacturer's catalogue number so that the medical device can be identified.
	<b>Serial number</b> Indicates the manufacturer's serial number so that a specific medical device can be identified.

Settings overview for your hearing aid				
Left			Right	
<input type="checkbox"/> Yes	<input type="checkbox"/> No	Volume wheel	<input type="checkbox"/> Yes	<input type="checkbox"/> No
<input type="checkbox"/> Yes	<input type="checkbox"/> No	Program shift	<input type="checkbox"/> Yes	<input type="checkbox"/> No
<input type="checkbox"/> Yes	<input type="checkbox"/> No	Mute	<input type="checkbox"/> Yes	<input type="checkbox"/> No
Volume control indicators				
<input type="checkbox"/> On	<input type="checkbox"/> Off	Beeps at min /max volume	<input type="checkbox"/> On	<input type="checkbox"/> Off
<input type="checkbox"/> On	<input type="checkbox"/> Off	Clicks when changing volume	<input type="checkbox"/> On	<input type="checkbox"/> Off
<input type="checkbox"/> On	<input type="checkbox"/> Off	Beeps at preferred volume	<input type="checkbox"/> On	<input type="checkbox"/> Off
Battery indicators				
<input type="checkbox"/> On	<input type="checkbox"/> Off	Low battery warning	<input type="checkbox"/> On	<input type="checkbox"/> Off
<input type="checkbox"/> On	<input type="checkbox"/> Off	Change battery	<input type="checkbox"/> On	<input type="checkbox"/> Off
<input type="checkbox"/> On	<input type="checkbox"/> Off	Reinsert earmould	<input type="checkbox"/> On	<input type="checkbox"/> Off

158475UK / 2018.3.22

158475UK / 2018.03.22



**oticon**  
PEOPLE FIRST

158475UK / 2018.03.22